

주어진 낱말을 읽으며 써 보세요.

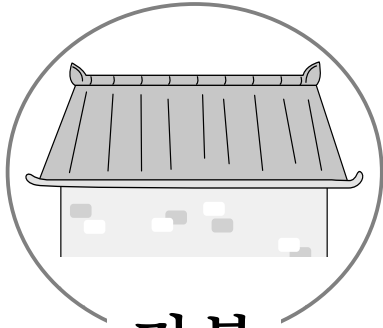

지붕

지	붕	지	붕

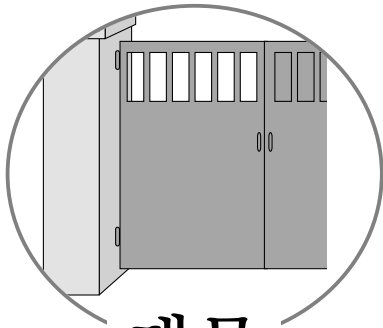

대문

대	문	대	문

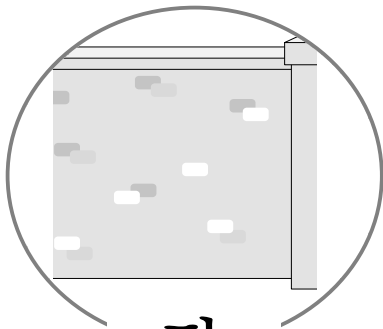

담

담	담		
---	---	--	--

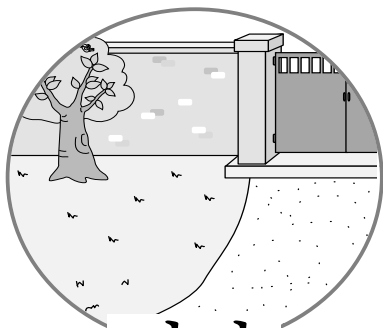

마당

마	당	마	당

주어진 낱말을 읽으며 써 보세요.



현관

현	관	현	관

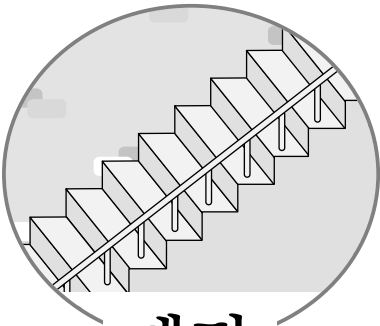

계단

계	단	계	단

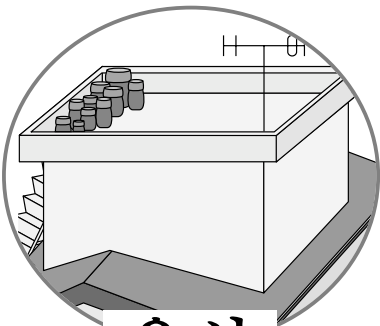

옥상

옥	상	옥	상

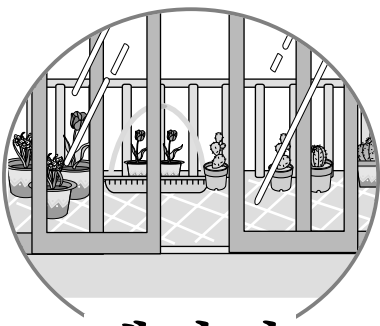

베란다

베	란다

주어진 낱말을 읽으며 써 보세요.

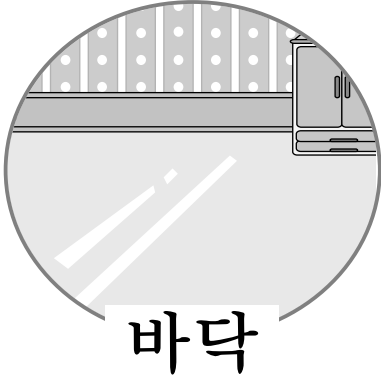

바	닥	바	닥

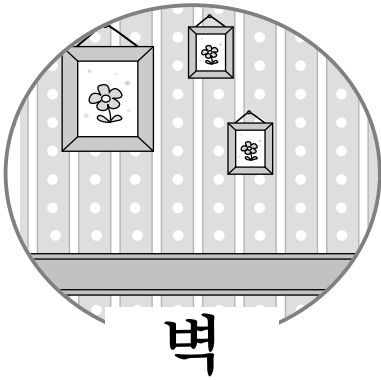

벽	벽		

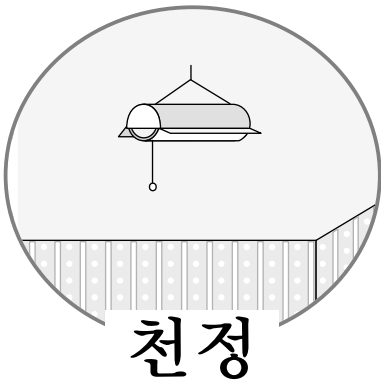

천	정	천	정

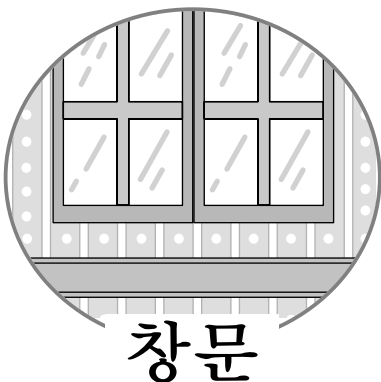

창	문	창	문

주어진 낱말을 읽으며 써 보세요.

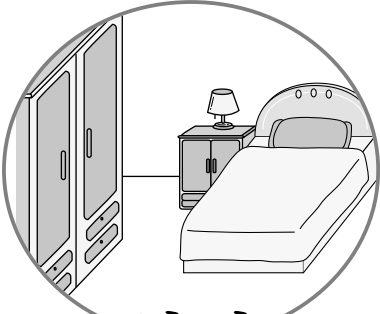

침실

침	실	침	실

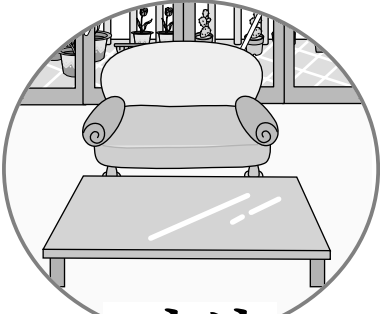

거실

거	실	거	실

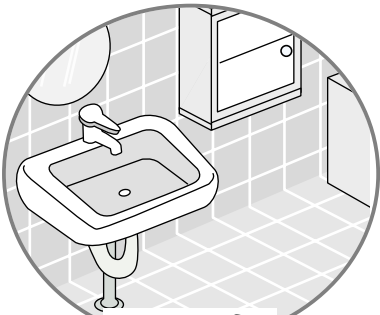

욕실

욕	실	욕	실

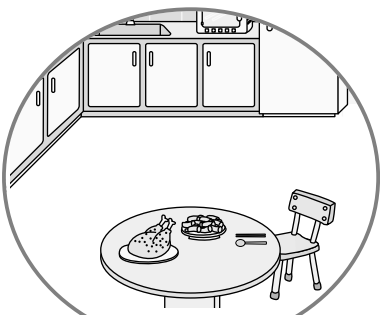

부엌

부	엌	부	엌

그림을 보고, 주어진 동물들이 있는 곳을 찾아 선으로 이어 보세요.

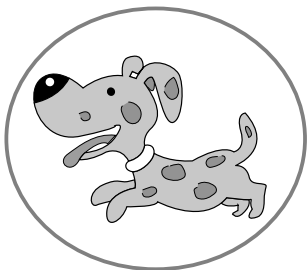
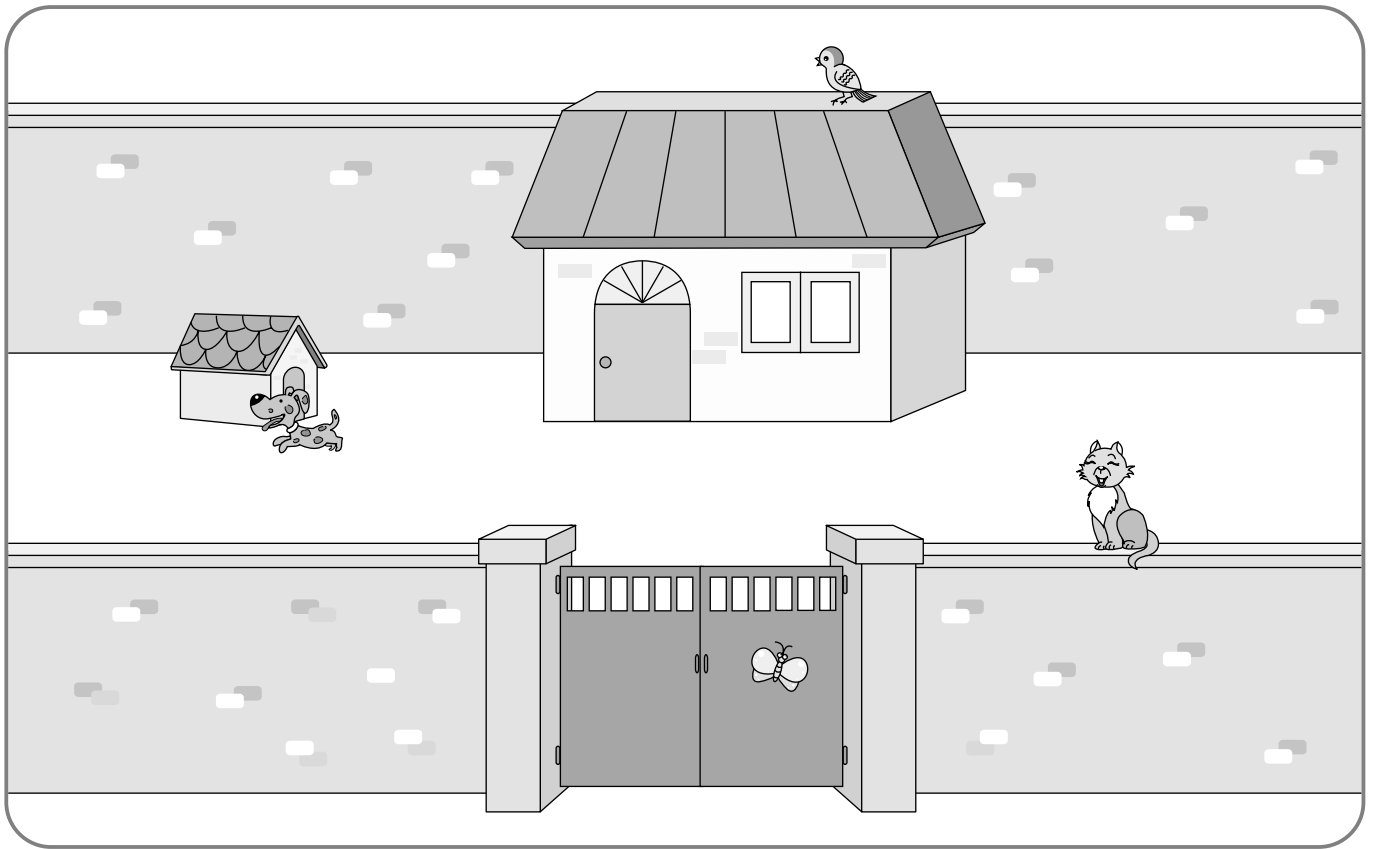

•

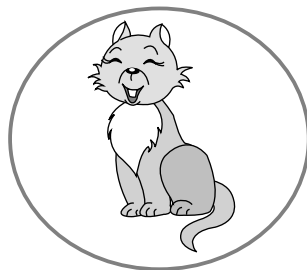

•

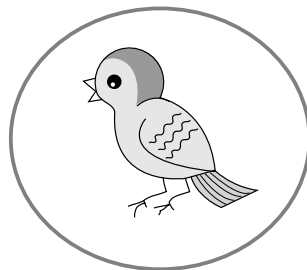

•

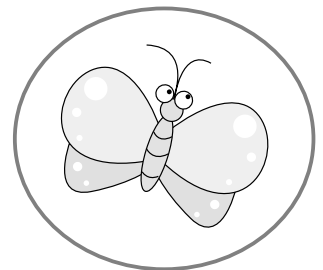

•

•

지붕

•

대문

•

담

•

마당

그림에 알맞은 이름을 골라 ○를 그려 보세요.

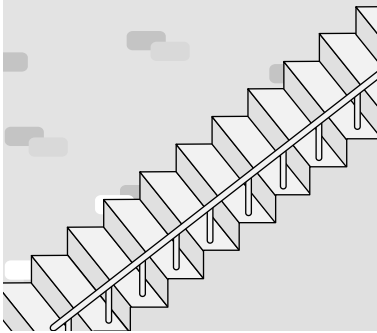

옥상

계단

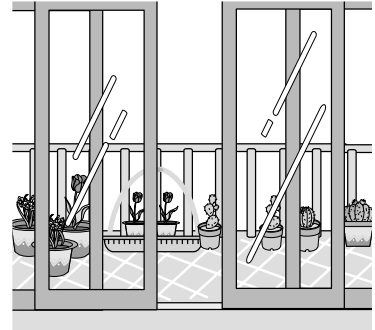

베란다

현관

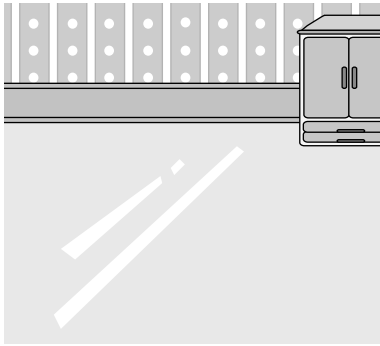

바닥

지붕

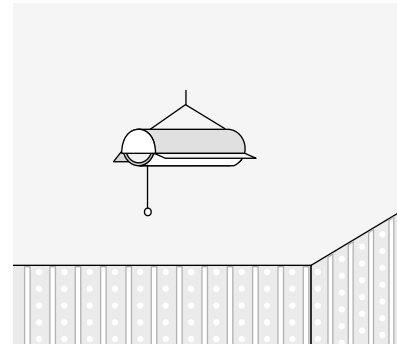

옥상

천정

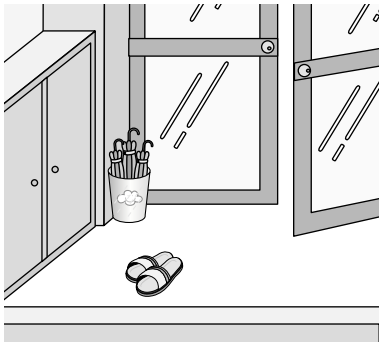

벽

현관

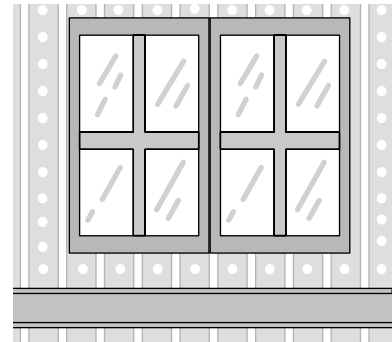

창문

베란다

◆ 어디에 있어야 할 물건인지 찾아 선으로 잇고, 써 보세요.

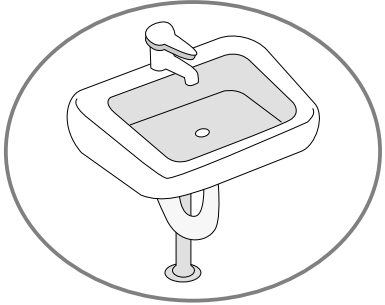

세면대

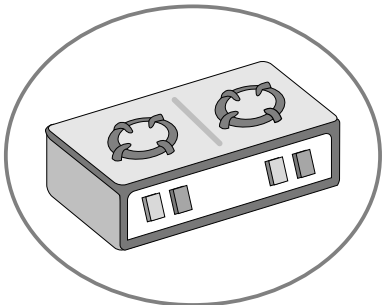
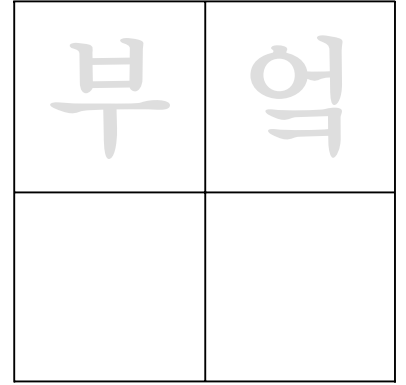

가스레인지

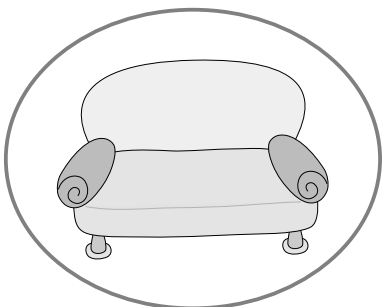
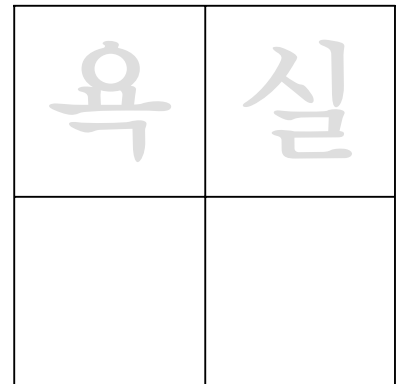

소파

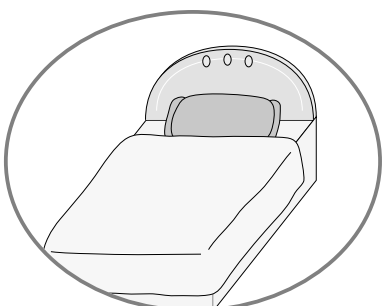
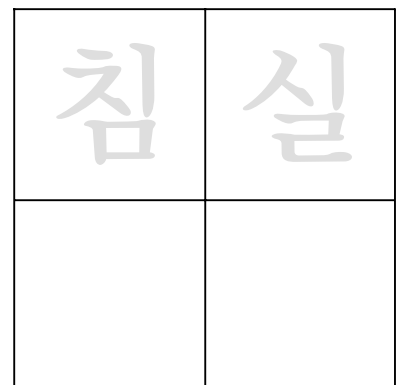

침대

